



Zigbee Pro Series

Product Introduction

Smart Lighting Happy Life





Contents

I .	Company profile	04
II .	3.0 vs RF	06
III .	Product classification	10
IV .	Indoor products	12
V .	Outdoor products	24
VI .	Function introduction	30



About Gledopto

GLEDOPTO CO.LTD focus on developing new products with innovative idea and latest technology.

WIRELESS TECHNOLOGY:

Manufacturing traditional LED products reborn with 2.4GHz standard ZIGBEE technology, RF remote control technology and rich LED experience.

GLEDOPTO CO., LTD is an industrial trading company located in Shenzhen, CN. since 2010.

üWith R&D team to provide OEM solution and customized products

üVarious products be released almost each season with the latest design

üOwns the updated machine, professional team with proficient skill

PRINCIPLE:

Good faith cooperation to create a win-win situation

Good quality is our responsibility to customers

Good quality is the only sustainable condition

Certificates



GLEDOPTO ZIGBEE PRO VERSION

Uses dual protocol of 2.4GHz ZIGBEE 3.0 and RF

06



ZIGBEE3.0

Gledopto system communicates with most zigbee systems from other providers, so you can easily extend the system with more different items.

- all your lamps can be operated from one bridge
- deliver a high interoperable wireless mesh network
- extremely low-power consumption
- remote control for convenience and security

HOW IT WORKS

1. plug GLEDOPTO light source to a power supply
2. connect the Zigbee Bridge(optional) to a power supply and connect to your router
3. download and install the Zigbee Bridge App
4. search and connect the light on the App's settings
5. create and modify your own zigbee network

Advantages

- Voice commands and smartphone activate
- Receive and process commands from multiple devices at the same time
- Operate and remember default/custom scenarios

RF

It is perfect for every smart home beginner who want to test the wireless control.

- No require the Zigbee bridge
- pairing and operate process even more simple

HOW IT WORKS

MATCH (more about "DELETE process" please refer the User Instruction)

1. battery power the wall switch or manual remote control
2. within 3s of power on the gledopto light source, press zone "1" (of any group you want the light in) to do the pairing.
3. the indicator turns green to show successfully paring
4. create and modify your own RF lights system

Advantages

- Each remote can match one or more receiver for group control
- Nine kinds of default color dynamic scenarios
- Ultra sensitive color&CCT adjustment touch wheel/bar



ZIGBEE 3.0



• **Power-up speed**

Within 1S



• **Lighting color transition to CCT temperature**

Smoother



• **Zigbee distance**

Mesh network

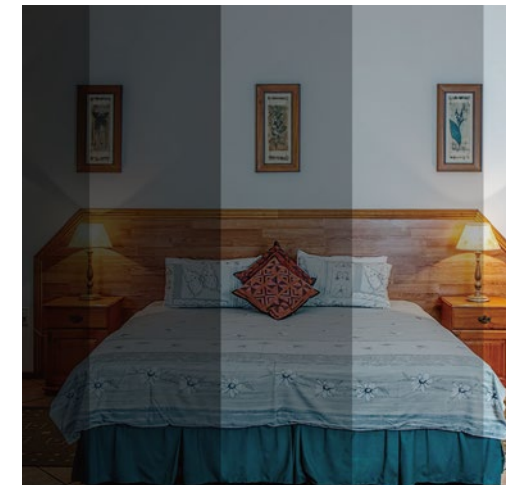

• **Minimum brightness**

Darker

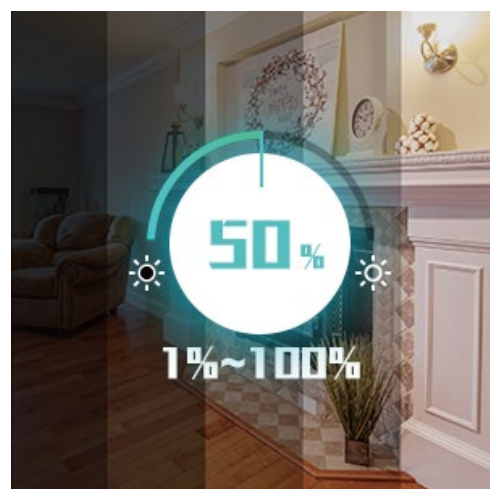

• **Adjust brightness**

Smoother

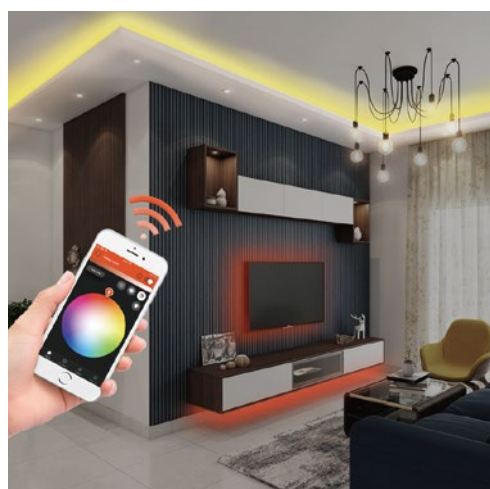

• **Adjust Color**

Smoother

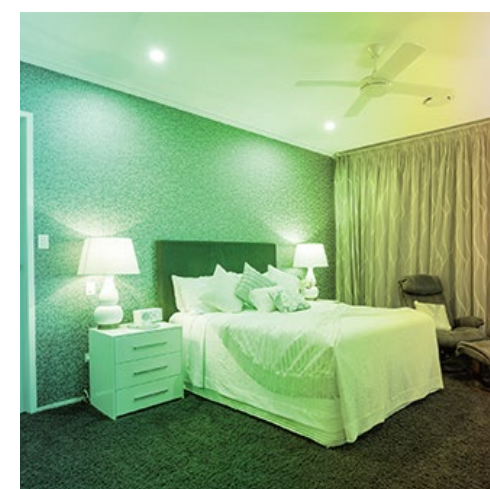

• **Multiple lights powered up simultaneously**

Lights up almost simultaneously

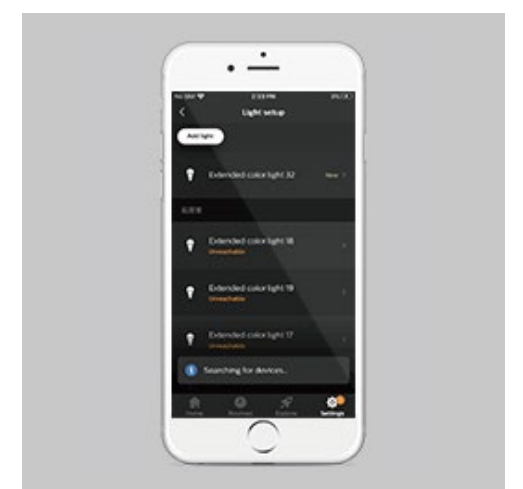

• **Search after resetting**

It's easy to search for lights

LED Controller

LED Bulb

LED Spotlight

LED Downlight

LED Flood light



RGB+CCT Controller Pro

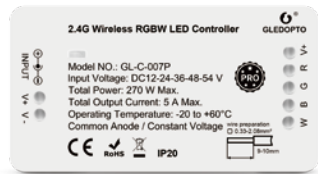

RGBW Controller Pro



WW/CW Controller Pro



Dimmer Controller Pro



Mini Strip Controller Pro



4W Candle Bulb Pro



6W LED Bulb Pro



12W LED Bulb Pro



4W LED GU10 Pro



4W LED MR16 Pro



6W LED Downlight Pro



9W LED Downlight Pro



12W LED Downlight Pro



10W Flood light Pro



30W Flood light Pro



60W Flood light Pro

LED Garden lamp



12W Garden lamp Pro

INDOOR PRODUCTS

My room is up to me.



LED Controller Pro

RGB+CCT

RGBW

WW/CW

Dimmer



16 million colors changing



Color temp adjustable



Brightness dimmable



Voice control



Smart phone APP control



Controlled by remote control



RGB+CCT Controller Pro (GL-C-008P)



RGBW Controller Pro (GL-C-007P)



WW/CW Controller Pro (GL-C-006P)

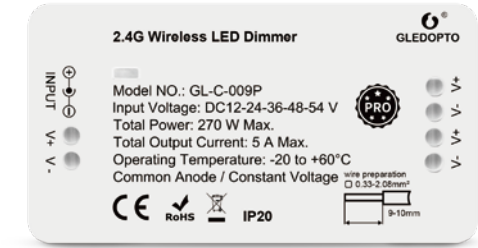

LED Dimmer Controller Pro (GL-C-009P)

Parameter

Input Voltage	DC12-24-36-48-54 V
Size	23.5x48x89mm
Total Power	270 W Max
Protection rate	IP20
Total Output Current	5 A Max
Operating Temperature	-20°C~60°C
Common Anode	
Constant Voltage	



Fireproof material
high temperature resistance.

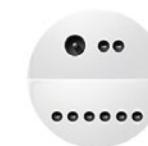

Press type Design
Wiring is more convenient.



Dual White and Color
color, brightness, color temperature and saturation can be adjusted.



Compatible gateways for zigbee 3.0
ZIGBEE transmission technology, MESH, multi signal at the same to transmit, receive, anti interference ability.

ZIGBEE

LED BULB Pro



Zigbee 6W LED Bulb Pro
(GL-B-007P)

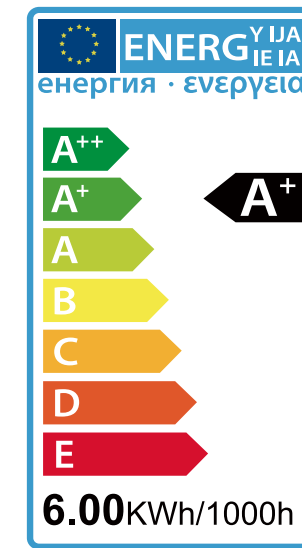

Parameter

Model NO.	GL-B-007P
Input Voltage	AC100~240V
Size	Φ57x102mm
Color temp	2000~6500K
Luminous Flux	500~550LM
Working temp	-20°C~60°C
G.W.	0.1KG
CRI	>80



Adopt imported high - grade PC transparent cover, transmittance 85%, The light distribution is more uniform, no dark spots, effectively reduce the adverse glare damage to the eyes.



The aluminum case is good for heat dissipation, high thermal conductivity, fast heat dissipation, and more durable.



International E27, E26 standard screw base, wide voltage design (100-240V), wide application, durable, universal. and saturation can be adjusted.

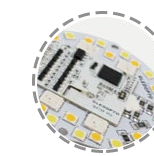

The Taiwan SMD 5050/3030 LEDs, EPISTAR, Low fever, high brightness, durable, use life of 50 thousand hours or so.

Zigbee 4W Candle Bulb Pro (GL-B-001P)

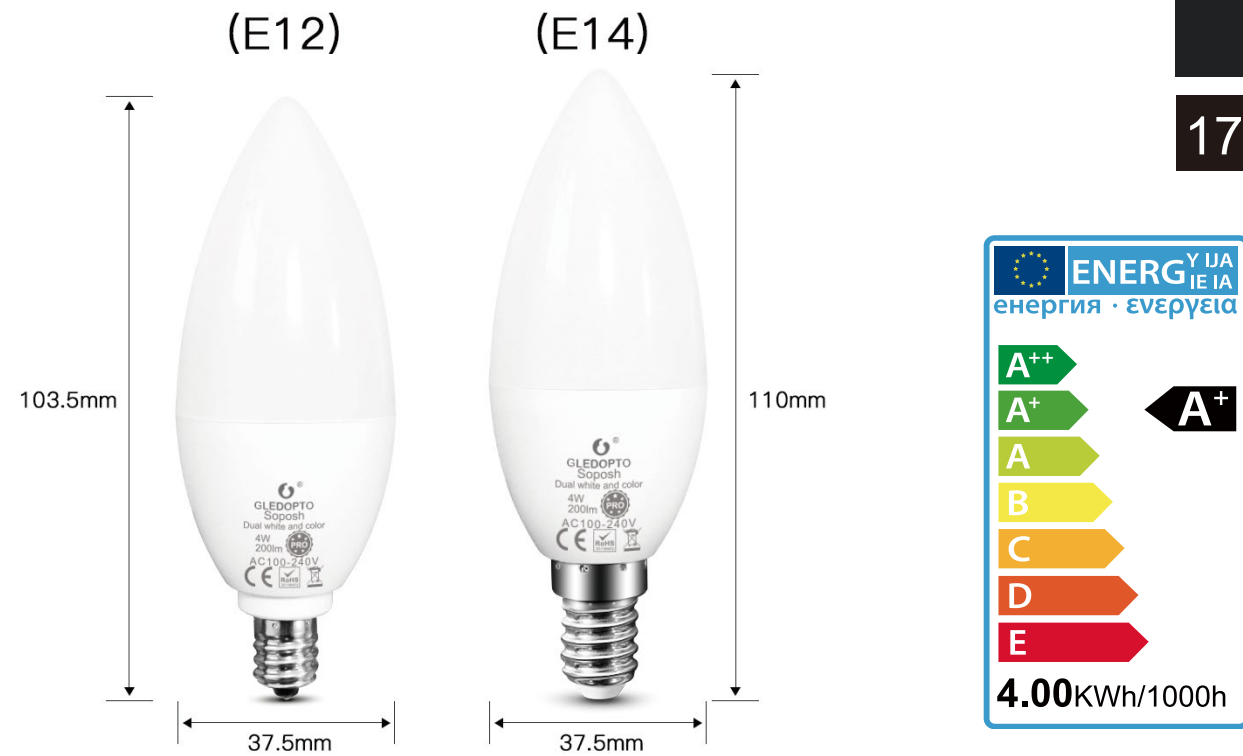

17

Parameter

Model NO.	GL-B-001P
Input Voltage	AC100~240V
Size	Φ37.5x103.5mm(E12) Φ37.5x110mm(E14)
Color temp	2000~6500K
Luminous Flux	250~300LM
Working temp	-20°C~60°C
G.W.	0.11KG
CRI	>80

Adopt high - grade PMMA Lens, transmittance 93%,The light distribution is more uniform, no dark spots, effectively reduce the adverse glare damage to the eyes.



Fireproof material,high temperature resistance, durable and reliable.

High-quality LED chips, Low fever, high brightness, durable, use life of 50 thousand hours or so.



E12/E14 wide voltage design (100-240V), wide application, durable, universal.

Zigbee 12W LED Bulb Pro (GL-B-008P)

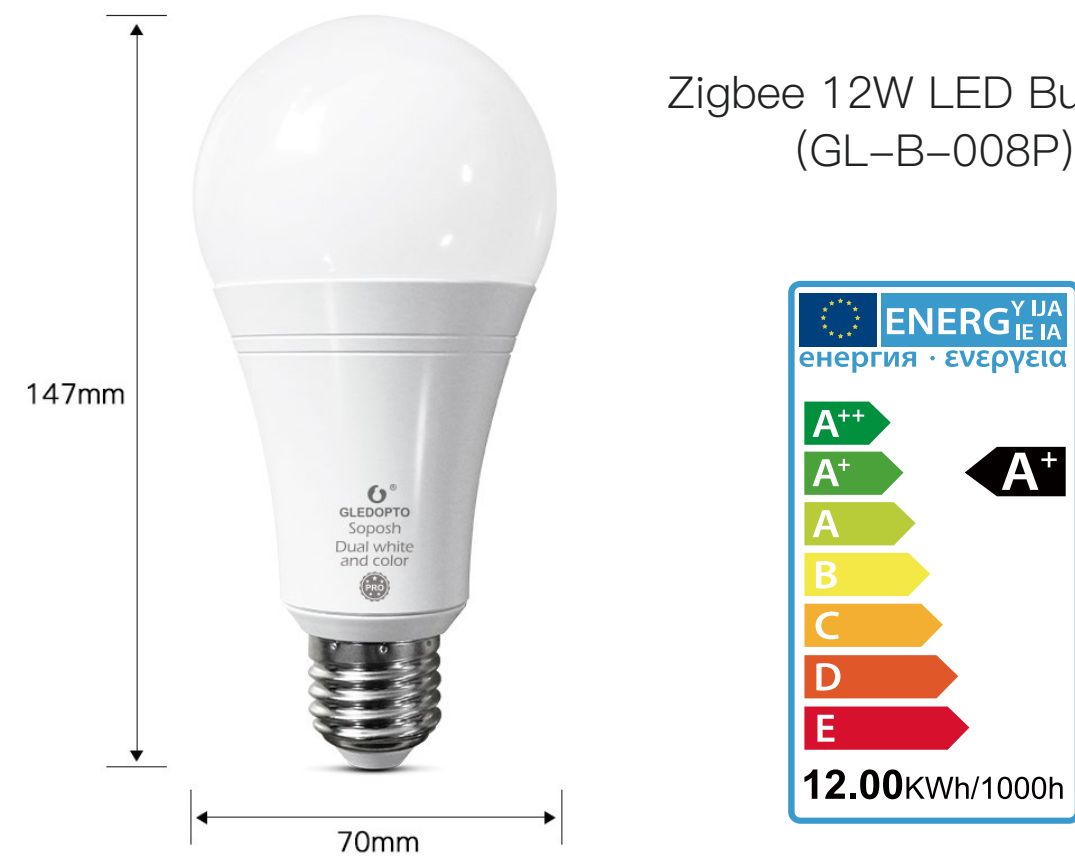

18

Parameter

Model NO.	GL-B-008P
Input Voltage	AC100~240V
Size	Φ70x147mm
Color temp	2000~6500K
Luminous Flux	900~1100LM
Working temp	-20°C~60°C
G.W.	0.3KG
CRI	>80

Adopt imported high - grade PC transparent cover, transmittance 85%, The light distribution is more uniform, no dark spots, effectively reduce the adverse glare damage to the eyes.



The aluminum case is good for heat dissipation, high thermal conductivity, fast heat dissipation, and more durable.







International E27, E26 standard screw base, wide voltage design (100-240V), wide application, durable, universal. and saturation can be adjusted.



The Taiwan SMD 5050/3030 LEDs, EPISTAR, Low fever, high brightness, durable, use life of 50 thousand hours or so.

Zigbee LED Spotlight Pro



-  16 million colors changing
-  Color temp adjustment
-  Brightness adjustment
-  Voice control
-  Smart phone APP control
-  Controller by remote control



Zigbee 4W MR16 Pro
(GL-S-004P)





Zigbee 4W GU10 Pro
(GL-S-007P)



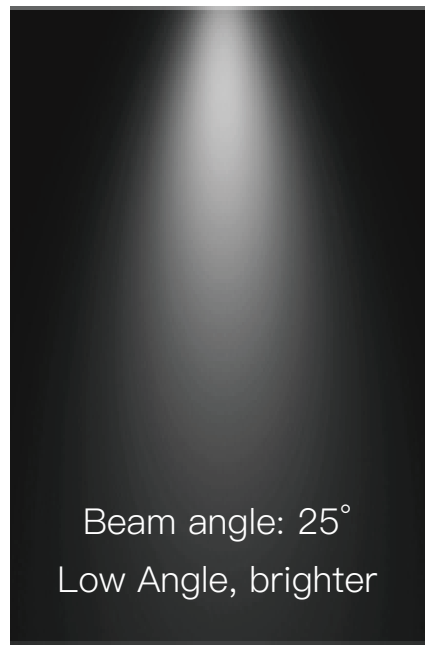

Parameter

Power	4W
Input Voltage	AC100~240V
Housing	Aluminum(GU10) Aluminum+Plastic(MR16)
Color temp	2000~6500K
Luminous Flux	250~300LM
Working temp	-20°C~60°C
Beam angle	25°
CRI	>80



 High-quality LED chips, Low fever, high brightness, durable, use life of 50 thousand hours or so.

 MR16 Low voltage design(AC/DC 12V), more secure, durable, universal.

 Adopt high - grade PMMA Lens, transmittance 93%,The light distribution is more uniform, no dark spots, effectively reduce the adverse glare damage to the eyes.

 Aluminum housing with better heat sink effect, the overall use of no welding process, ensure the quality of products is high, more excellent performance.

ZIGBEE

6W/9W/12W LED Downlight Pro



16 million colors changing



Color temp adjustment



Brightness adjustment

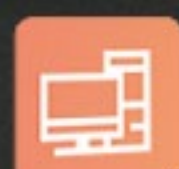

Wide compatibility



Voice control



Smart phone APP control

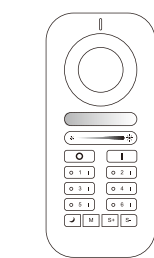

Auto-transfer

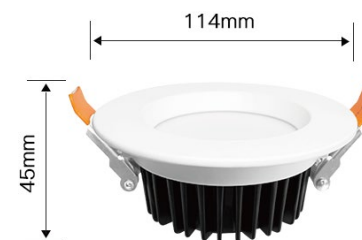
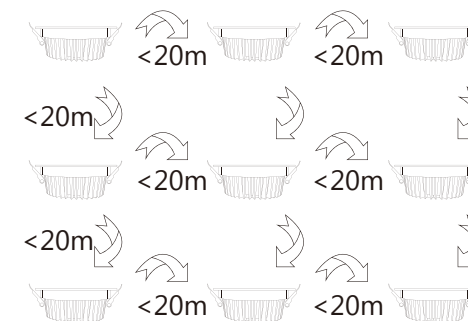

(GL-D-003P)

6W



(GL-D-004P)

9W



(GL-D-005P)

12W

Parameter

Power	6W	9W	12W
Hole Size	100~110mm	100~110mm	130~140mm
Cutout	3.9~4.3in	3.9~4.3in	5.1~5.5in
Luminous Flux	500~550LM	800~850LM	1000~1050LM
CRI	>80		
PF	>0.5		
Lifespan	50000 hours		
Input Voltage	AC 100~240V		
Color temperature	2000~6500K		
Light Efficiency	88LM/W		
Material	Aluminum+PC Cover		

1. Please open the hole on the ceiling according to the correct size of Diagram 1.
2. Push in the two spring elements, make sure that they are deployed and anchored on the back of the ceiling Diagram 2 and 3.
3. Connect the driver properly according to the wire connection Diagram 4.

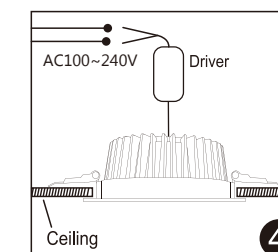
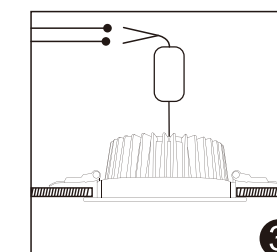
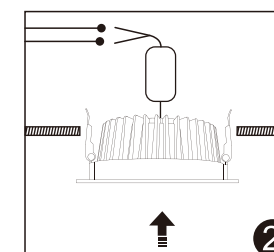
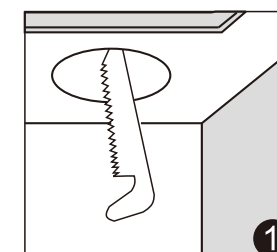

OUTDOOR PRODUCTS

Outdoor lighting can be just as wonderful.



ZIGBEE

LED Floodlight Pro



Voice control



Brightness Controllable



16 million colors changing



Smart phone APP control



CCT Adjustable



Controlled by remote control

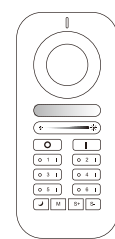

Auto-transfer

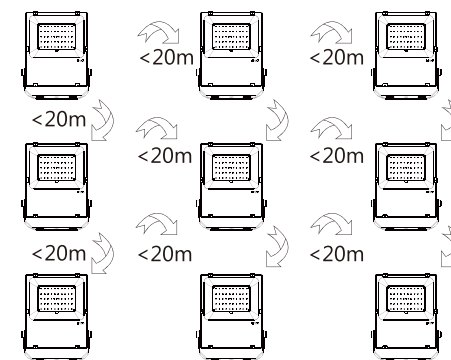

Parameter

Picture			
Power	10W	30W	60W
Model NO.	GL-FL-004P	GL-FL-005P	GL-FL-006P
Luminous Flux	650~850LM	2100~2700LM	4500~5000LM
Size(mm)	166x107x32	226.5x167x40	309.5x267.5x182.2
NW(g)	450	950	1800
GW(g)	550	1160	2100
Driver	Customized	Mean Well	Mean Well
Protection	IP65	IP65	IP65
Warranty	3years	3years	3years
LED color	Dual White And Color		
Input voltage	AC100~240V		
Color temperature	2000K~6500K		
Working temp	-20~60°C		
Line length	0.6m		
Life span	50,000h		
Material	Aluminum, toughened glass		
Compatible with Zigbee bridge			

Picture			
Power	100W	200W	400W
Model NO.	GL-FL-007P	GL-FL-008P	GL-FL-010P
Luminous Flux	7500~8000LM	20000~25000LM	25000~30000LM
Size(mm)	402x295x60	470x360x60	480x480x600
NW(g)	3600	8000	14500
GW(g)	4000	8500	15000
Driver	Mean Well	Mean Well	Mean Well
Protection	IP65	IP65	IP65
Warranty	3years	3years	3years
LED color	Dual White And Color		
Input voltage	AC100~240V		
Color temperature	2000K~6500K		
Working temp	-20~60°C		
Line length	0.6m		
Life span	50,000h		
Material	Aluminum, toughened glass		
Compatible with Zigbee bridge			



Pure aluminium reflector

The reflector is made of pure aluminium (99.8%) which anti-oxidation and unfading in colour, ensuring the reflection.



Tempered glass panel

4 mm tempered glass panel safely protect the lighting source, and the transparent rate is up to 93%.



Wide angel for adjustment

With multiple adjustment points the adjustment angel can be up to 270°.

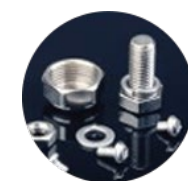

Stainless steel parts

Endurancing the corrosion of air, chemical acid, alkaline, salt and other materials, can be used in all kinds of harsh conditions for long term.



Electrophoretic paint shell

Processed by electrophoretic paint, measured by 200hours salt test, the entire housing has excellent corrosion resistance.



High Quality Plug&Cable

US/UK/AU/EU standard plug, rubber cable x3M, H05RN-F/SJOW

12W

GARDEN LAMP PRO



Zigbee 12W
Garden lamp Pro
(GL-G-001P)

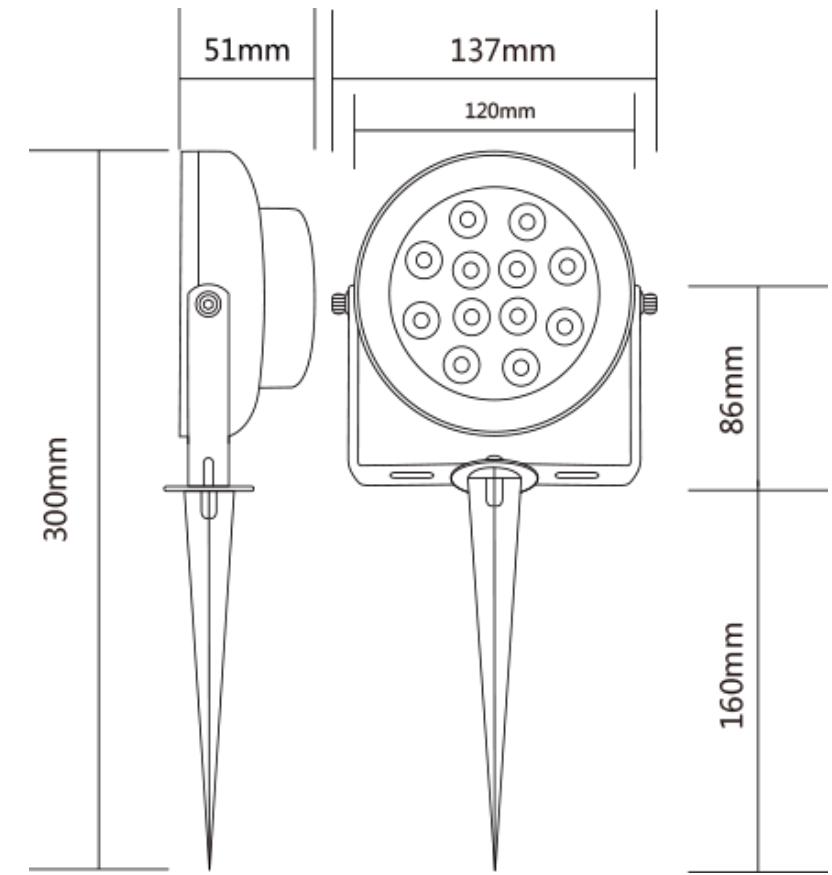

Parameter

Model NO.	GL-G-001P
Input Voltage	AC100~240V/50~60Hz
Size	137x300x51mm
Color temp	2000~6500K
Luminous Flux	850~900LM
Beam Angle	25°
PF	>0.5
CRI	>80
IP Rate	IP65



16 million colors changing



Color temp adjustable



Brightness dimmable



Voice control



Smart phone APP control



Controlled by remote control



The Taiwan EPISTAR 3030 chip distribution 15, Low fever, high brightness, durable, use life of 50 thousand hours or so.



It's easy for customers to change the angle.



High quality Aluminum, longer and stronger anticorrosion.



US/UK/AU/EU standard plug, rubber cable x 3M.



FUNCTION INTRODUCTION

Multifunctional and multi-application.



Smart Lighting · Happy Life

Function introduction

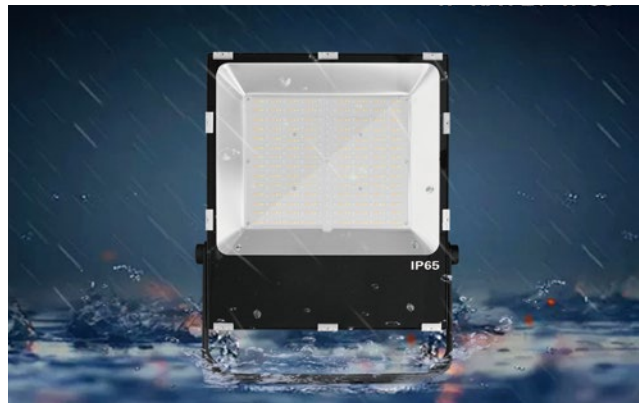

• **Professional waterproof**

Professional waterproof technology, superior waterproof performance, protection level of IP65, no need to worry about rain and humidity.

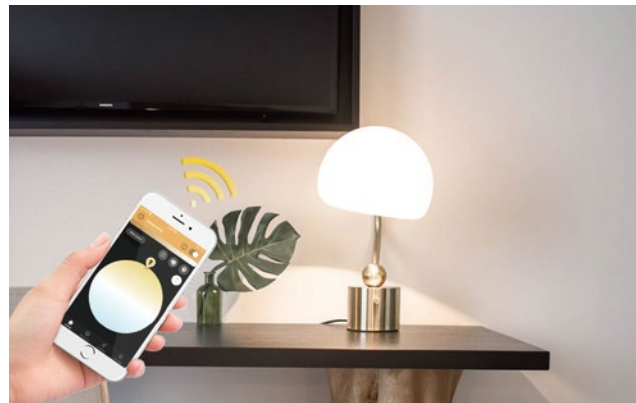

• **Smart phone APP control**

You can control the lights in all rooms through the phone app, making your life more convenient.

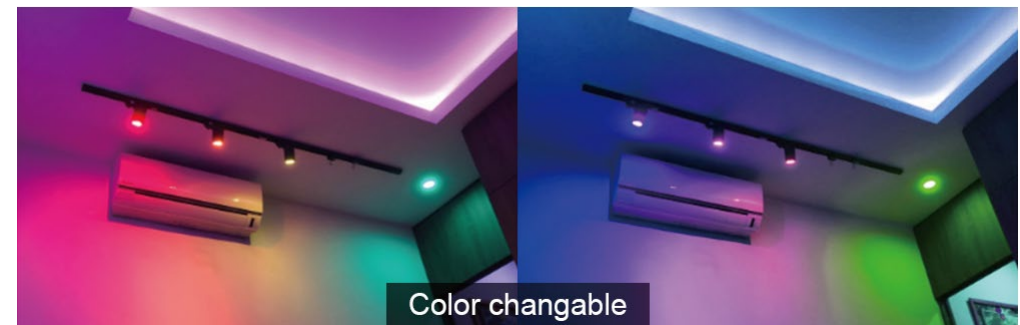

• **16million color changing**

16 million colors for you to choose and make your life colorful.



• **Color temperature regulation**

Color temperature change from 2000K to 6500K.



• **Works with Amazon echo plus**

adjust on/off , brightness , and change light colors through your voice command.



• **2.4G RF Remote Control**

You can use the remote control to control the light directly, without the zigbee gateway.



• **Brightness adjustment**

Choose the right brightness according to your needs.